

Features

LineLED LL Series Double Row is a small profile high performance LED strip. It offers excellent color quality with 96+ CRI and 89+ R9 values across the entire range of outputs, while sustaining efficacy above 89 lumens per watt. The LL60X2 consists of two outputs ranging from over 660 to over 830 lumens per foot. Industry-best color consistency is ensured with single-binned LEDs. The durable but flexible product features heavier copper weight for improved heat dissipation and reduced voltage drop.

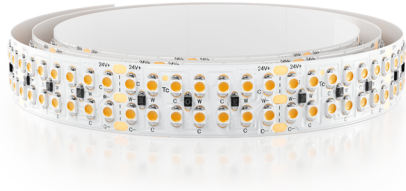

Mounting

LED strip is equipped with 3M™ self-adhesive tape.

Applications

Indoor only - millwork, cove, architectural reveals, undercabinet, display case, handrail, accent lighting.

Approvals

Class 2 damp listed

Operating voltage

24 VDC

Average Life (L70)

50,000 hours

Warranty

5 years



Technical Information

TYPE	LL60X2	
	HO	VHO
OUTPUT OPTIONS		
Lumens Output (3000K)	668 lm/ft	834 lm/ft
Average Power Consumption (for a 4' section)	7.3 W/ft	9.4 W/ft
Efficacy	92 lm/W	89 lm/W
Cutting Increment (in)	1.41"	
Pitch Length	0.2"	
Max Run Length (in series)	26 ft	21 ft
Dimensions	0.63"W x 0.09" H	

CCT	Multiplier (reference - 3000K)	TM-30			
		CRI	R _f	R _g	R ₉
2200K	0.70	96	95	101	89
2400K	0.72	98	97	101	91
2700K	0.74	97	96	101	91
3000K	1.00	97	95	104	97
3500K	1.02	97	94	105	97
4100K	1.07	97	90	99	97

Section Start/End Options

SL

Soldered lead wires (72")

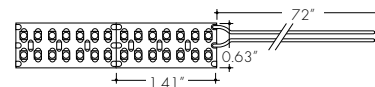

LF

Lead Female 3" cable

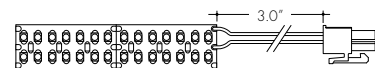

LM

Lead Male 3" cable

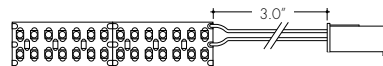

NC

No connector

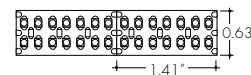

Ordering code

MODEL	OUTPUT	CCT	SECTION START	SECTION END	LENGTH
LL60X2-LineLED Double Row LL60X2	HO-High VHO-Very High	22K-2200K 24K-2400K 27K-2700K 30K-3000K 35K-3500K 41K-4100K	SL-Soldered lead wires (72") LF-Female Quick Connect LM-Male Quick Connect NC-No Connector	SL-Soldered lead wires (72") LF-Female Quick Connect LM-Male Quick Connect NC-No Connector	Ordered in one foot increments. See chart above for max run length.

Accessories

CL2
Mounting Clip

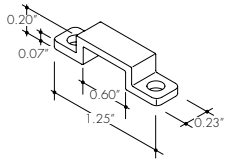

recommended at every 12" when lineLED strip is facing down.

LVSP-4T-BK
Splice Box

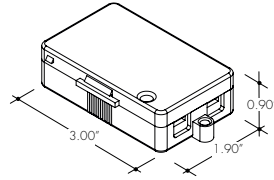

low voltage, 4 terminal splice box, black.

LL.ZIP
Cable/Wire Strain Relief Clip

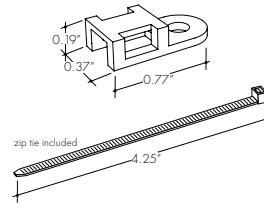

Lens Options / Light Transmission

C
Clear

HF
Half (50%)
Frosted

GR
Graze

F
Frosted

FF
Flat
Frosted

R
Raised

S
Square
Frosted

Q
Round Square
Frosted

13°
13°
Semi-Frosted

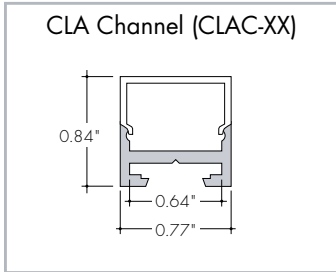

S **Q**
62% 65%

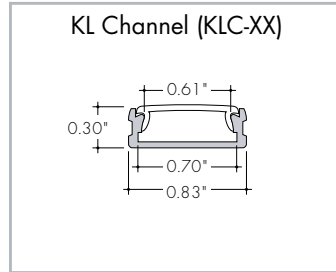

C **HF** **F**
81% 67% 51%

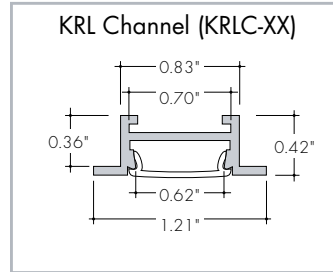

C **HF** **F**
81% 67% 51%

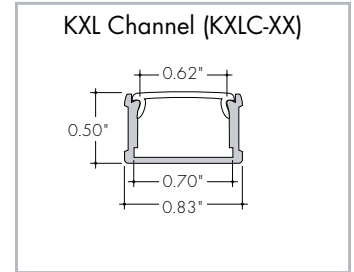

C **HF** **F**
79% 66% 49%

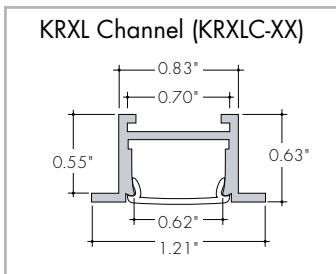

C **HF** **F**
79% 66% 49%

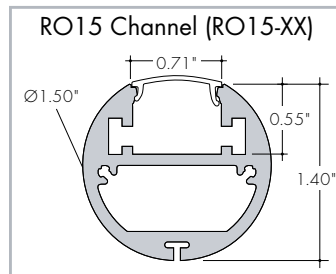

C **F**
65% 41%

Installation

All mounting channels are field cuttable using miter saw with circular blade suitable for cutting aluminum.

Ordering

Extrusions are sold separately. View respective specsheets for details on ordering extrusions and their accessories (endcaps, mounting brackets, etc).

Led Dotting per Extrusion

using the frosted lens option

Extrusion	LED Models
	LL60X2
KL	SD
KXL	ND
CLA	ND
KRL	SD
KRXL	ND
RO15	ND
MCAL	ND

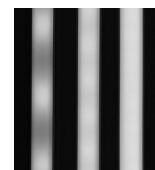

CD **SD** **ND**
CD - Clear Dotting
SD - Slight Dotting
ND - No Dotting

TM-30-15: Data

2200K

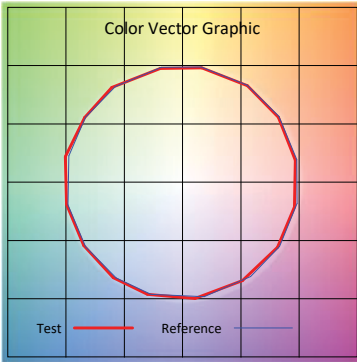

Hue Bin	Rf	Graphic Shifts (%)	
		Chroma	Hue
1	96.8	-1.4%	-0.2%
2	97.4	-0.7%	-0.3%
3	96.2	-0.5%	-0.4%
4	97.5	-0.8%	-1.0%
5	97.3	-0.8%	1.1%
6	95.4	1.0%	2.8%
7	98.1	0.5%	0.6%
8	95.7	2.8%	1.3%
9	97.0	1.1%	-0.8%
10	96.4	0.6%	-1.6%
11	96.0	1.3%	-2.2%
12	94.7	0.8%	-3.0%
13	92.0	0.2%	-7.8%
14	87.2	-1.1%	-7.9%
15	96.6	-0.9%	-1.7%
16	94.1	-1.6%	-3.2%

2400K

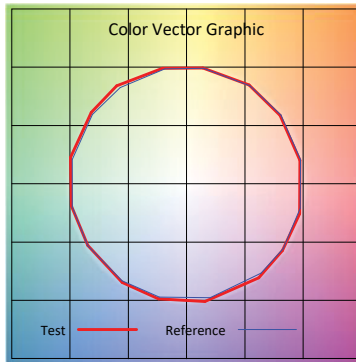

Hue Bin	Rf	Graphic Shifts (%)	
		Chroma	Hue
1	97.3	-0.7%	-0.6%
2	98.0	-0.7%	0.1%
3	96.7	0.1%	1.2%
4	97.4	0.0%	0.5%
5	97.0	1.0%	1.9%
6	95.0	2.9%	1.6%
7	96.4	1.7%	-0.9%
8	96.2	1.9%	-1.3%
9	97.2	0.4%	-1.1%
10	97.9	-0.3%	-0.3%
11	96.9	1.2%	1.2%
12	94.8	1.7%	-0.4%
13	93.6	2.2%	-4.9%
14	92.7	2.2%	-3.9%
15	96.7	0.4%	-2.0%
16	92.9	0.3%	-4.7%

2700K

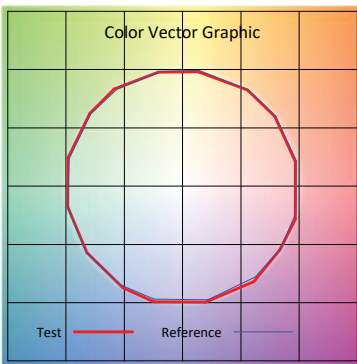

Hue Bin	Rf	Graphic Shifts (%)	
		Chroma	Hue
1	97.1	-1.0%	-0.6%
2	98.2	-0.7%	-0.2%
3	97.0	-0.5%	0.8%
4	97.1	-1.2%	0.2%
5	96.9	-0.1%	1.9%
6	96.2	1.7%	1.8%
7	97.3	0.8%	-0.1%
8	97.9	1.0%	-0.3%
9	98.2	-0.1%	-0.1%
10	96.8	-0.2%	1.5%
11	94.8	0.9%	3.0%
12	94.4	2.4%	0.2%
13	95.7	1.6%	-2.4%
14	94.2	2.7%	-3.1%
15	96.5	-0.0%	-1.4%
16	92.3	0.7%	-5.3%

3000K

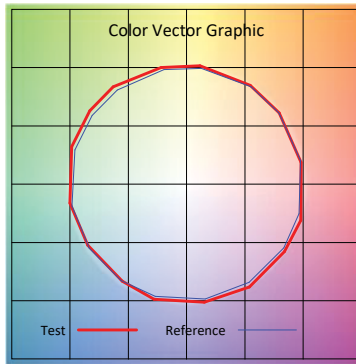

Hue Bin	Rf	Graphic Shifts (%)	
		Chroma	Hue
1	95.9	0.2%	-1.7%
2	97.4	0.2%	-0.2%
3	96.3	0.7%	1.2%
4	95.1	1.9%	1.6%
5	94.9	2.3%	2.1%
6	92.6	4.3%	1.2%
7	92.1	3.9%	-2.2%
8	93.1	3.3%	-2.3%
9	94.8	1.2%	-2.8%
10	94.6	-0.5%	-2.7%
11	96.2	-0.1%	1.0%
12	93.7	2.7%	-0.3%
13	95.7	2.5%	-1.3%
14	94.2	3.6%	-2.1%
15	94.2	2.2%	-2.5%
16	92.0	2.5%	-5.3%

3500K

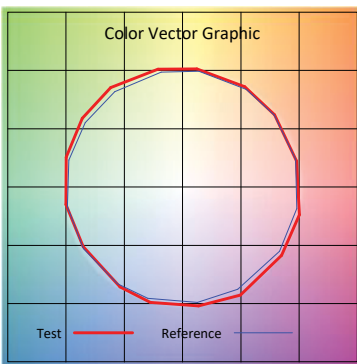

Hue Bin	Rf	Graphic Shifts (%)	
		Chroma	Hue
1	96.4	0.5%	-1.5%
2	97.7	0.3%	0.2%
3	94.7	1.0%	2.2%
4	94.4	1.7%	2.2%
5	93.4	3.0%	2.3%
6	91.4	5.0%	1.0%
7	92.7	4.1%	-1.6%
8	94.1	2.8%	-2.1%
9	95.0	0.9%	-2.1%
10	95.9	-0.8%	-1.6%
11	93.5	1.1%	3.4%
12	91.7	3.1%	3.0%
13	95.3	3.1%	0.5%
14	93.0	5.3%	-0.8%
15	93.5	3.4%	-2.1%
16	90.9	3.2%	-4.6%

4100K

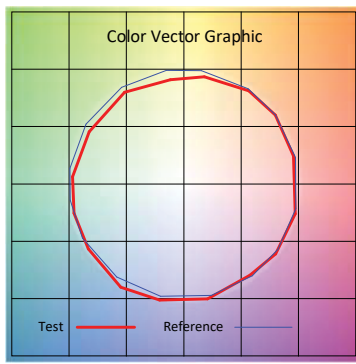

Hue Bin	Rf	Graphic Shifts (%)	
		Chroma	Hue
1	91.5	-1.3%	1.6%
2	95.3	-0.1%	-0.4%
3	95.4	-1.0%	-1.3%
4	89.1	-4.8%	-3.5%
5	86.6	-8.7%	-2.1%
6	91.9	-5.0%	0.5%
7	87.8	-6.2%	4.0%
8	86.7	-3.5%	6.7%
9	82.7	-1.2%	11.7%
10	81.6	1.0%	10.5%
11	84.5	5.4%	8.0%
12	92.6	3.3%	-0.3%
13	90.9	2.3%	3.9%
14	92.6	-1.5%	-1.5%
15	86.6	0.5%	-4.4%
16	86.7	0.5%	-4.7%

Power Consumption

Tested at full power with PDC Series power supplies.

Nominal Length	LL60X2-HO		LL60X2-VHO	
	W/ft	Total Wattage	W/ft	Total Wattage
1	8.2	8.9	10.4	11.3
2	7.8	15.5	10.1	20.2
3	7.6	23.3	9.7	29.9
4	7.3	29.3	9.3	37.4
5	7.2	35.9	9.2	45.8
6	7.0	41.9	8.8	52.9
7	6.7	47.2	8.5	59.2
8	6.6	52.6	8.3	66.4
9	6.4	57.9	7.7	69.3
10	6.3	63.5	7.4	74.2
11	6.1	67.6	6.9	75.4
12	5.9	70.8	6.5	77.8
13	5.7	73.8	6.2	80.6
14	5.5	76.6	6.0	83.1
15	5.3	79.2	5.7	86.2
16	5.0	80.0	5.3	85.6
17	4.9	82.6	5.3	90.8
18	4.7	84.3	4.9	88.2
19	4.5	86.0	4.9	92.9
20	4.4	88.6	4.7	94.5
21	4.2	88.9	4.5	95.2
22	4.1	89.7		
23	3.9	90.0		
24	3.8	90.8		
25	3.7	91.1		
26	3.5	91.9		

Voltage Drop Calculator

The below chart assumes nominal voltage of 24 Volts and a Voltage Drop Allowance of 3% through the wire

Wattage [W]	Maximum Wire Length From Power Supply to Start of Run [ft]						
	12 AWG	14 AWG	16 AWG	18 AWG	20 AWG	22 AWG	24 AWG
5	1088.2	684.4	430.3	270.6	170.2	107.1	67.3
10	544.1	342.2	215.1	135.3	85.1	53.5	33.7
15	362.7	228.1	143.4	90.2	56.7	35.7	22.4
20	272.0	171.1	107.6	67.7	42.6	26.8	16.8
25	217.6	136.9	86.1	54.1	34.0	21.4	13.5
30	181.4	114.1	71.7	45.1	28.4	17.8	11.2
35	155.5	97.8	61.5	38.7	24.3	15.3	9.6
40	136.0	85.5	53.8	33.8	21.3	13.4	8.4
45	120.9	76.0	47.8	30.1	18.9	11.9	7.5
50	108.8	68.4	43.0	27.1	17.0	10.7	6.7
55	98.9	62.2	39.1	24.6	15.5	9.7	6.1
60	90.7	57.0	35.9	22.6	14.2	8.9	5.6
65	83.7	52.6	33.1	20.8	13.1	8.2	5.2
70	77.7	48.9	30.7	19.3	12.2	7.6	4.8
75	72.5	45.6	28.7	18.0	11.3	7.1	4.5
80	68.0	42.8	26.9	16.9	10.6	6.7	4.2
85	64.0	40.3	25.3	15.9	10.0	6.3	4.0
90	60.5	38.0	23.9	15.0	9.5	5.9	3.7
96	56.7	35.6	22.4	14.1	8.9	5.6	3.5

Power Supplies

See Power Supply instructions and spec sheet for wiring information. For a complete list of compatible dimmers, see [Compatible Dimming Chart](#) on the Resources page.

0-10V Dimming Power Supplies 0.1% 120VAC - 277VAC

MODEL	POWER	OUTPUT	DIMMING
PS010V - 0-10V Power Supply dims down to 0.1%	96 - 96 Watt 3X96 - 3 X 96 Watt	24 - 24 VDC	LIN - Linear LOG - Logarithmic

MODELS	96W	3X96
Length	14.40"	13.00"
Width	5.20"	6.62"
Depth	2.60"	4.20"

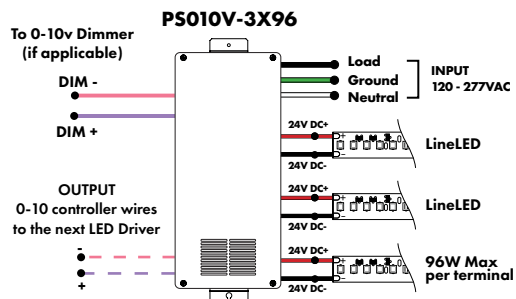
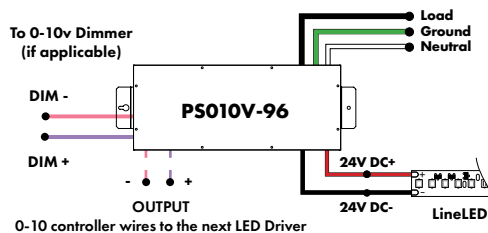

DALI 0% Dimming Power Supplies 120VAC - 277VAC

MODEL	POWER	OUTPUT
PSDALI - DALI Power Supply dims down to 0%	96 - 96 Watt 3X96 - 3 X 96 Watt	24 - 24 VDC

Features eldoLED's LINEARdrive configurable dimmable drivers

Model	96W	3X96
Length	14.40"	13.00"
Width	5.20"	6.62"
Depth	2.60"	4.20"

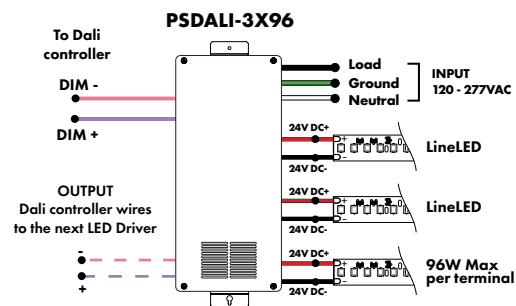
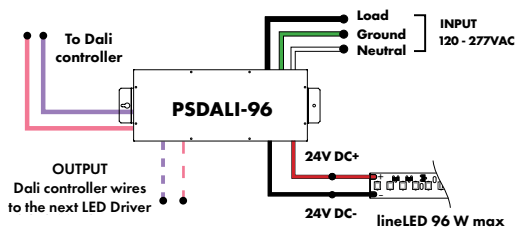

Universal Power Supply 1% 120VAC - 277VAC

MODEL	POWER	OUTPUT
PDCU-D - IP20 Dry Series	30 - 30 W 60 - 60 W 96 - 96 W 3X96 - 3X96 W	24 - 24 VDC
PDCU-W - IP66 Wet Series	96 - 96 W 3X96 - 3X96 W	

0-10V dims down to 1%, MLV/ELV/TRIAC dims down to 1%.
For a complete list of compatible dimmers, see [Compatible Dimming Chart](#) on the Resources page.

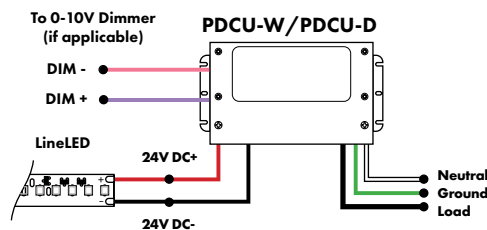

MODEL	PDCU-W-96W	PDCU-W-3X96W	PDCU-D-30W	PDCU-D-60W	PDCU-D-96W	PDCU-D-3X96W
Length	8.66"	11.85"	6.10"	7.93"	8.25"	9.57"
Width	3.73"	4.32"	3.35"	3.35"	4.10"	5.94"
Depth	1.61"	1.81"	1.33"	1.32"	1.56"	1.13"

Power Supplies

See Power Supply instructions and spec sheet for wiring information. For a complete list of compatible dimmers, see Compatible Dimming Chart on the Resources page.

Customizable Dim to Warm or Variable White via 0 - 10V (for tunable white or warm dimming control of Dynamic option)

MODEL	POWER	OUTPUT	CONTROL
PS010VD-0-10V Vintage Dim LED Driver	96-96 Watt	24-24 VDC	W2I-Standard dimming for both tapes

*Zonal control power supplies

MODELS	96W
Length	14.40"
Width	5.20"
Depth	2.60"

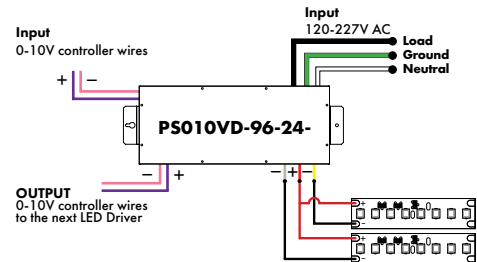

Non-Dimming Power Supply 120VAC - 277VAC

MODEL	POWER	OUTPUT	DIMMING	LOCATION
PSV - PSV Series	96 - 96 Watt	24 - 24 VDC	ND - Non Dimming	D - Damp

MODELS	96W
Length	8.25"
Width	3.75"
Depth	1.63"

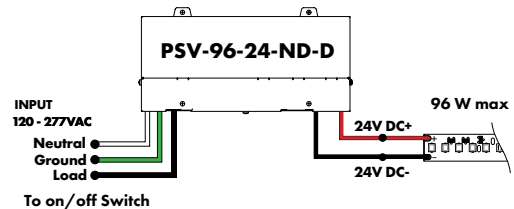

Enlighted Enabled Dimming Power Supplies 120VAC - 277VAC

MODEL	POWER	OUTPUT	DIMMING	LOCATION
PSV - PSV Series	96 - 96 Watt	24 - 24 VDC	ENL - Enlighted Dimming dims down to 0%	D - Damp

Model	96W
Length	14.40"
Width	5.20"
Depth	2.60"

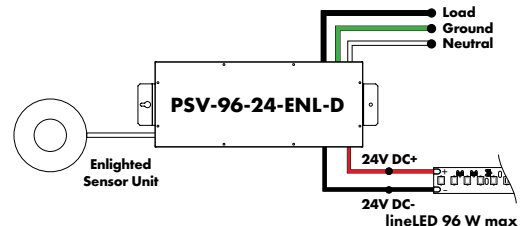

Triac, MLV, ELV Compatible Dimmers

MODEL	POWER	OUTPUT
PDC - (IP20) Power Supply	96 - 96 Watts	24 - 24 VDC

MODELS	96W
Length	8.25"
Width	4.10"
Depth	1.56"

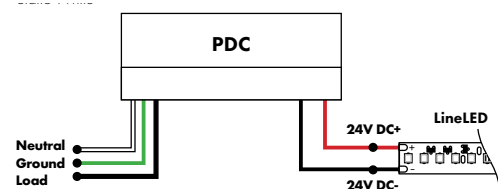

Power Supplies

See Power Supply instructions and spec sheet for wiring information. For a complete list of compatible dimmers, see Compatible Dimming Chart on the Resources page.

In-Ground Power Supplies

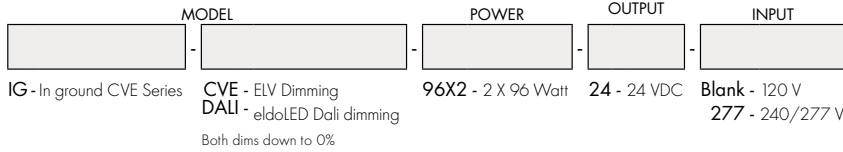

MODEL	Dual Circuit
Length	8.40"
Width	8.30"
Depth	8.10"

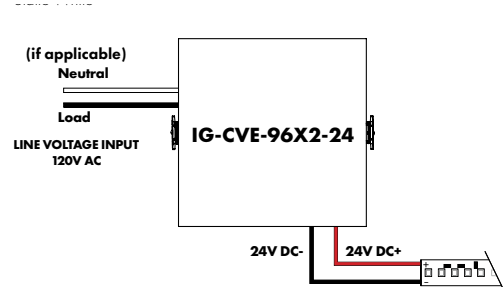

Luminii is a Lutron OEM Advantage Partner

Lutron Power Supplies 0.1%

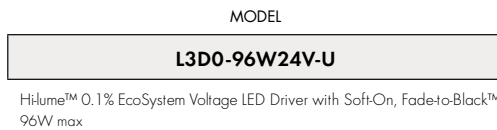

MODELS	L3D0
Length	10.50"
Width	5.50"
Depth	2.00"

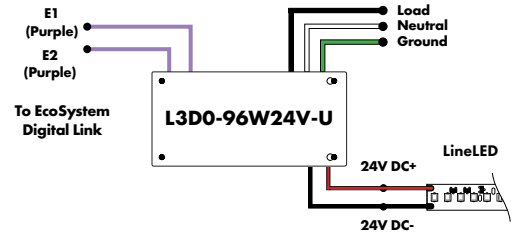

DMX Dimming Power Supplies 120VAC - 277VAC

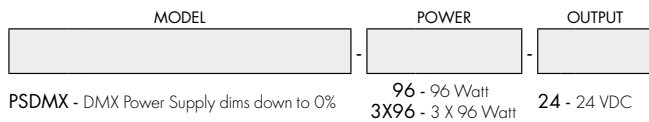

PSDMX - DMX Power Supply dims down to 0%

Features eldoLED's LINEARdrive configurable dimmable drivers

*Zonal control power supplies. Control multiple tapes/zones using DMX channels.

MODEL	96W	3X96
Length	14.40"	13.00"
Width	5.20"	6.60"
Depth	2.60"	4.20"

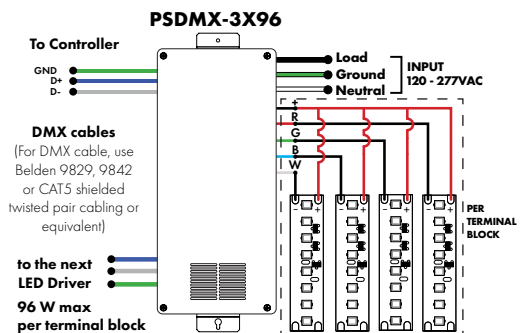
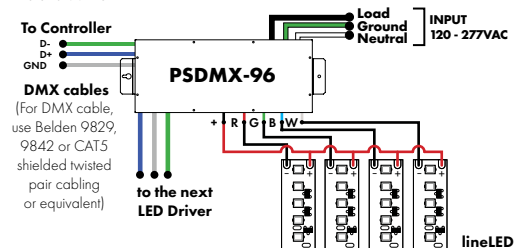

Decoders



MODEL

DDMX-5CH-RDM-PRO

DDMX-5CH-RDM-PRO - DMX512 Decoder

DMX512 decoder with RDM functionality features 5 PWM output channels with common anode. High PWM output frequency range allows the product to be used in HD video conferencing spaces. All DMX products to be installed per DMX512 Standard.

Power
96 Watt

Inputs
RJ45, XLR-5Pin, Terminal Block

DMX Channels
1 to 5 settable

PWM Output Resolution Ratio
8 or 16 bit

PWM Output Frequency
500Hz - 30KHz

Output Dimming Curve Gamma Value
0.1 ~ 9.9



MODEL

DDMX-RGBW

DDMX-RGBW - DMX512 Decoder

Translates controller DMX512 programs for RGB and white LED strips.

Unique DMX address for the decoder can be set easily and displayed by the numeric display on the case. Changing and resetting the DMX address requires manual input.

Use power repeater to expand output (Luminii part# RGBW-SR).

Operating Voltage
12-36 VDC

Power Capacity
up to 96W at 24V

Operating Temperature Range
from -4°F to +122°F in case

PWM Output Frequency
200Hz or 1500Hz



MODEL

RGBW-RC-R

RGBW-RC-R - RGBW receiver

The RGBW receiver is easily paired with controller by the click of a button. Receiver can be reset to factory settings at any time.

Each receiver can store one static RGB color, one color sequence, and one brightness setting for the white LED strip. Receivers assigned to the same scene within the same zone will have the same LED static color and color sequence.

Operating Voltage
12-36 VDC

Power Capacity
up to 96W at 24V

Operating Temperature Range
from -4°F to +122°F in case

Decoders



MODEL

RGBW-SR

RGBW-SR - RGBW signal repeater

Extends identical signal when connected in series to an RGBW LED control system. The RGBW signal repeater works with Luminii RGB and RGBW controllers, receivers, and decoders.

RGBW signal can be extended indefinitely when adequate power supply (not included) is connected to the system.

Operating Voltage
12-36 VDC

Power Capacity
up to 96W at 24V

Operating Temperature Range
from -4°F to +122°F in case



MODEL

RGBW-WiR

RGBW-WiR - WiFi generator

RGBW-WiR creates a local network that enables any electronic device (phone, tablet, etc.) to control the RGB/W strip connected to a RGBW-RC-R receiver.

The control functions are achieved through a free application download for Android and iOS devices called REALCOLOR.

Operating Voltage
12-36 VDC

Power Supply
PI-130-24 (included)

Operating Temperature Range
from -4°F to +122°F in case

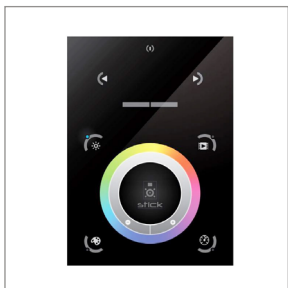

MODEL

TSDMX-E

TSDMX-E - Touchscreen DMX controller

Programmable advanced DMX512 lighting controller featuring a touch-screen interface. Operates as stand alone controller or integrated with most architectural lighting control systems. Can controller endless DMX512 enabled devices.

Mounts to standard single or dual gang wall box with the included power supply inside the junction box. Terminal block design for power and data connections.

Features

- Sleek glass design which sits 0.43" from the wall
- Graphical color display to show selected environment
- Color/dimmer/speed palette
- Color temperature mixing
- Touch sensitive buttons. No mechanical parts
- Touch sensitive wheel allows for accurate color selection
- Multi-zone microSD memory
- Multi-room control with 500 scenes, 10 zones
- 1024 DMX channels. Control 340 RGB fixtures
- USB & Ethernet connectivity for programming and control

Power Supply

7 VDC (included)

Programmability

PC, Mac, Tablet, Smartphone

Output Signal

DMX512 (1024 channels)

Color Parameters

- Brightness
- Saturation
- Speed of color changing sequence
- Fading / dimming / brightness