

# LETO 44 Mini WM

WALL MOUNT LED DOWNLIGHT

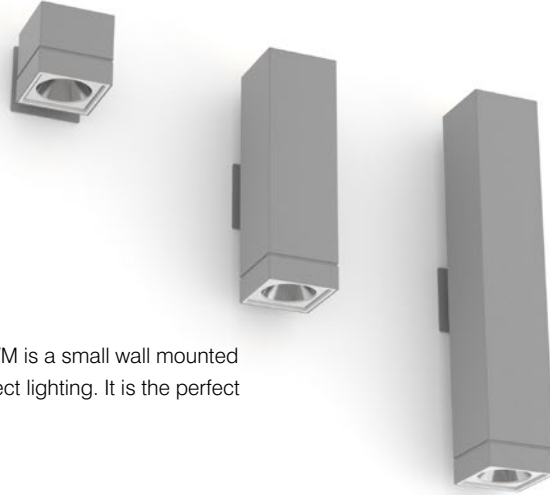

**Leto 44 Mini WM - Wall Mount LED Downlight.** Leto 44 Mini WM is a small wall mounted cylinder LED fixture designed to provide a space with discrete direct lighting. It is the perfect solution for creating subtle light in your space.

## Ordering Code

Fixture	<b>742</b>								
	1	2	3	4	5	6	7	8	9
Driver					--	--			
	1	2	3	4	5	6			

## Product Specifications

**SAMPLE:** Fixture **742 - S - A90 - 617 - 27 - 07 - 00 - 08 - 02** | Driver **951 - 01 - STD - 120 - A90 - 07**

1 - Model	2 - Size	3 - CRI/LED	4 - Optic	5 - CCT	6 - Lumen
<b>742</b> · Leto 44 Mini Wall Mount	<b>S</b> · Small (73mm) <b>M</b> · Medium (209mm) <b>L</b> · Large (346mm)	<b>A90</b> · Accuracy (93+ CRI) <b>CT</b> · Color Tuning <sup>CT</sup> (90 CRI) <b>WD</b> · Warm Dimming <sup>WD</sup> (90 CRI)	<b>617</b> · 17° <b>624</b> · 24° <b>660</b> · 60°	<b>25</b> · 2500K <b>27</b> · 2700K <b>30</b> · 3000K <sup>WD</sup> <b>35</b> · 3500K <b>40</b> · 4000K <b>65</b> · 6500K <b>2765</b> · 2700K - 6500K <sup>CT</sup>	<b>07</b> · 700 (6.1W) <sup>WD</sup> <b>10</b> · 1000 (9.1W) <sup>WD</sup> <b>15</b> · 1500 (14W) <sup>CT</sup>

7 - Accessory	8 - Body Color	9 - Baffle Color	1 - Canopy Style	2 - Canopy Color
<b>00</b> · No Accessory <b>DL</b> · Diffusing Film <b>HO</b> · Honeycomb**	<i>Standard</i> <b>01</b> · White <b>02</b> · Black <b>08</b> · Silver <i>Premium</i> <b>52</b> · Mocha <b>53</b> · Charcoal <b>54</b> · Cerulean <b>55</b> · Firebrick <b>BZ</b> · Bronze <b>WN</b> · Warm Nickel <b>AB</b> · Aged Brass <b>XX</b> · RAL	<i>Standard</i> <b>01</b> · White <b>02</b> · Black <b>08</b> · Silver <i>Premium</i> <b>52</b> · Mocha <b>53</b> · Charcoal <b>54</b> · Cerulean <b>55</b> · Firebrick <b>BZ</b> · Bronze <b>WN</b> · Warm Nickel <b>AB</b> · Aged Brass <b>XX</b> · RAL	<b>955</b> · Round Slim <b>965</b> · Square Slim <b>954</b> · Round Semi-Recessed	<i>Standard</i> <b>01</b> · White <b>02</b> · Black <b>08</b> · Silver <i>Premium</i> <b>52</b> · Mocha <b>53</b> · Charcoal <b>54</b> · Cerulean <b>55</b> · Firebrick <b>BZ</b> · Bronze <b>WN</b> · Warm Nickel <b>AB</b> · Aged Brass <b>XX</b> · RAL

3 - Driver	Dim Level	Dim Level	4 - Voltage	5 - CRI/LED	6 - Lumen
<b>STD</b> · Non Dimming* <sup>5</sup> <b>LCS</b> · 0 - 10 Volt Protocol* <sup>5</sup> <b>DIM</b> · Phase* <sup>2/5</sup> <b>ELDOLC</b> · EldoLED 0 - 10 Volt* <sup>3</sup>	N/A 1% 1% 0.1%	<b>DALI</b> · Dali Protocol* <sup>3</sup> <b>LUTES</b> · Hilume Ecodigital* <sup>3</sup> <b>LUT2W</b> · 2 Wire for phase* <sup>2/3</sup> <b>CSMB</b> · Casambi Wireless Control* <sup>3/CT</sup>	0.1% 1% 1% 1% <sup>3/CT</sup>	<b>120</b> · 120V <b>277</b> · 277V <b>347</b> · 347V* <sup>3/4</sup>	Same as Fixture Same as Fixture

\*1 not available with small size

\*2 120V only

\*3 remote mount

\*4 not available with DALI or Lutron drivers

\*5 Can be junction box mounted with **955** and **965**. See page 2 for details.



# LETO 44 Mini WM

WALL MOUNT LED DOWNLIGHT



## Light Engine: A90 Accuracy

- Output:** up to 1500lm
- High Efficacy:** up to 110 lumen/Watt
- Color Options (CCT):** 2500K, 2700K, 3000K, 3500K, 4000K, 6500K
- Color Consistency:** Range within a 3-MacAdam Ellipse
- Color rendering (CRI):** 93+CRI & 50+ R9 Value

## Driver

- Dimming:** 1% dimming standard with 0.1% option
- Ripple:** Industry leading Low ripple
- Efficiency:** Power Factor >0.9  
Efficiency over 85%  
Class 2 output for safety

## Light Engine: Warm Dimming

- Output:** 1300lm
- High Efficacy:** up to 98 lumen/Watt
- Color Temperature (CCT):** 3000K dimmed to 1800K
- Color Consistency:** Range within a 3-MacAdam Ellipse
- Color rendering (CRI):** 90 CRI

## Driver

- Dimming:** 1% dimming standard with 0.1% option  
Dimmer switch must be capable of dimming less than 5% (Lutron DIVA is recommended)
- Ripple:** Industry leading Low ripple
- Efficiency:** Power Factor >0.9  
Efficiency over 85%  
Class 2 output for safety
- Installation:** Small Footprint allows retrofit installations

## Light Engine: Color Tuning

- Output:** up to 1300lm
- High Efficacy:** up to 95 lumen/Watt
- Color Temperature (CCT):** 2700K up to 6500K
- Color Consistency:** Range within a 3-MacAdam Ellipse
- Color rendering (CRI):** 90 CRI

## Driver

- Dimming:** Dali and DMX
- Ripple:** Industry leading Low ripple
- Efficiency:** Power Factor >0.9  
Efficiency over 85%  
Class 2 output for safety
- Installation:** Small Footprint allows retrofit installations

## Installation

- Pre-assembled for quick installation
- Low profile against the wall gives a floating appearance

## Construction

- Machined aluminum construction
- Powder coated in standard or premium finishes
- Made in Canada

## Dimensions

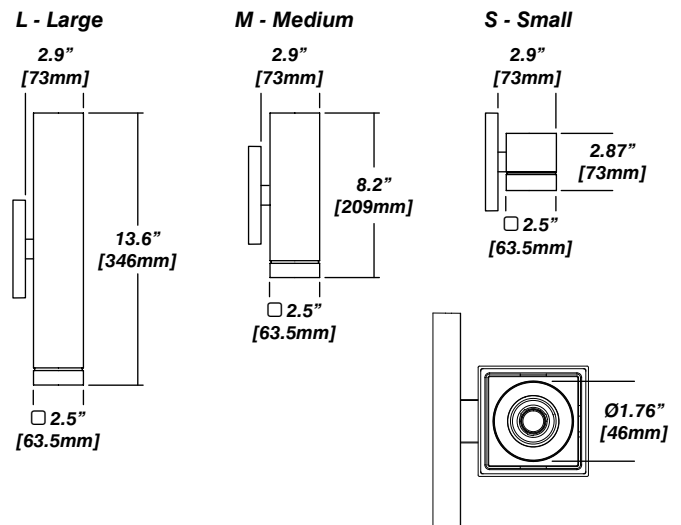

## Driver Placement

- **Standard, LCS, and Phase dimming** drivers may be mounted in the junction box.
- Minimum volume required to mount drivers in junction box:  
**70mm x 40mm x 30mm**

J-box - BC54151-LD  
or equivalent  
1.5" x 4"

STD / LCS / DIM  
Driver

Canopy Mounting  
Bracket for:  
955 Round Slim Canopy  
965 Square Slim Canopy

# LETO 44 Mini WM

WALL MOUNT LED DOWNLIGHT

## Accessories

*Diffusing Film*

*Honeycomb*



## Standard Finishes

01 - White

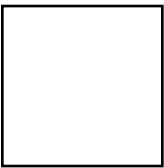

02 - Black



08 - Silver



## Premium Finishes

55 - Mocha



56 - Charcoal



57 - Cerulean



58 - Firebrick



BZ - Bronze



WN - Warm Nickel



AB - Aged Brass

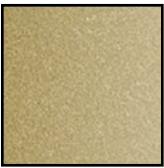

## Canopy

955 - Round Slim

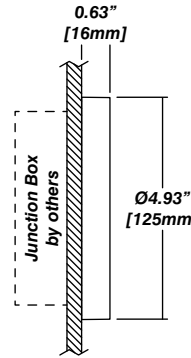

965 - Square Slim

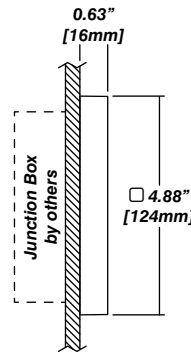

954 - Semi-Recessed + Cylinder Driver Housing

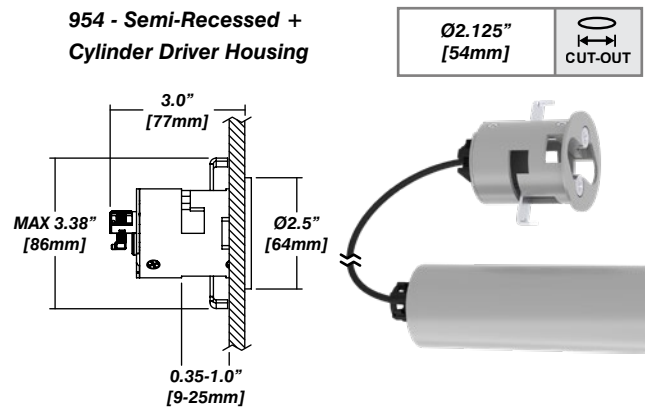

# LETO 44 Mini WM

WALL MOUNT LED DOWNLIGHT

## Senso Driver Housings

### 910 - Single Remote Driver Housing

- Fits Standard, LCS or DIM drivers
- Galvanized steel enclosure
- Installed in remote location

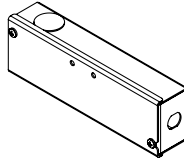

## Dimensions

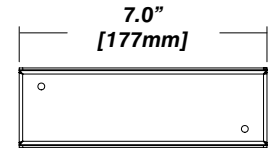
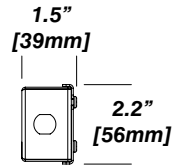

### 910 - Double Remote Driver Housing

- Fits all drivers
- Galvanized steel enclosure
- Installed in remote location

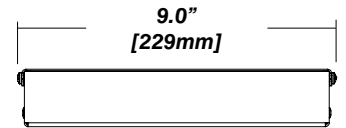
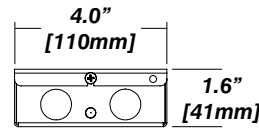
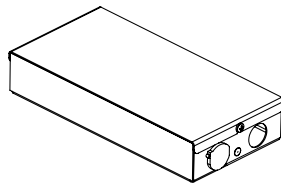

### 954 - Cylinder Driver Housing

- Supplied standard with every semi-recessed canopy
- Fits Standard, LCS or DIM drivers
- Extruded aluminum enclosure with strain relief to fixture
- Installed in ceiling beside canopy

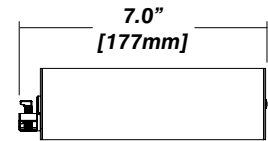
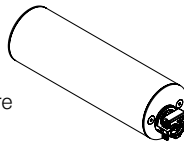

## 954 Driver Layouts

### 954 with Cylinder Driver Housing

- Installed in ceiling beside canopy
- Driver mounted inside cylinder
- Dimming control wired from Cylinder Driver Housing

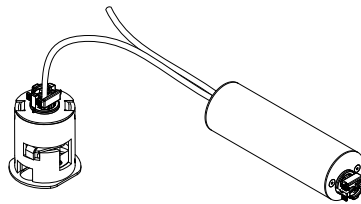

### 954 with 910 Single Driver Housing

- Driver remotely mounted inside 910 housing
- Fed to 910 housing
- WAGO connector for DC side
- Thermal protector for high temperatures

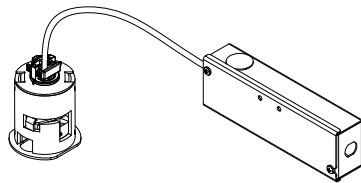

### 954 with 910 Double Driver Housing

- Driver remotely mounted inside 910 housing
- Fed to 910 housing
- WAGO connector for DC side
- Thermal protector for high temperatures

