

LETO 11 WM A

WALL MOUNT ASYMMETRIC LED DOWNLIGHT



Leto 11 WM A - Wall Mount LED Light. LETO 11 WM A is a wall mounted cylinder LED fixture that casts light away from the wall filling your space with more functional indirect light.

Ordering Code

Fixture	745A		--					
	1	2	3	4	5	6	7	8
Driver			--	--				
	1	2	3	4				

Product Specifications

SAMPLE: Fixture **745A - A90 - - - 27 - 07 - DL - 08 - 02** | Driver **00 - STD - 120 - A90 - 07**

1 - Model	2 - LED	3 - Optic	4 - CCT	5 - Lumen	6 - Accessory	7 - Body Color
745A · Leto 11 WM A	A90 · 93+ CRI Accuracy	<i>Leto 11 WM A is equipped with a fixed beam spread. For other optics please contact SENSO.</i>	25 · 2500K 27 · 2700K 30 · 3000K 35 · 3500K 40 · 4000K 65 · 6500K	07 · 700 (6.1W) 10 · 1000 (9.1W) 15 · 1500 (14W)	DL · Diffusing Lens	<i>Standard</i> 01 · White 02 · Black 08 · Silver <i>Premium</i> 52 · Mocha 53 · Charcoal 54 · Cerulean 55 · Firebrick XX · RAL

8 - Baffle Color	1 - Housing	1 - Driver	Dim Level	Dim Level
<i>Standard</i> 01 · White 02 · Black 08 · Silver <i>Premium</i> 52 · Mocha 53 · Charcoal 54 · Cerulean 55 · Firebrick XX · RAL	00 · Integral Driver 910 · Remote Driver Housing	STD · Non Dimming LCS · 0 - 10 Volt Protocol DIM · Phase*1 ELDOLC · EldoLED 0 - 10 Volt*2 DALI · Dali Protocol*2	N/A 1% 1% 0.1% 0.1%	LUTES · Hilume Ecodigital*2 1% LUT2W · 2 Wire for phase*1/2 1% DMX · SENSO*2 EMG · Emergency Driver*2/3 CSMB · Casambi Wireless Control*2/3

2 - Voltage	3 - LED	4 - Lumen	
120 · 120V 277 · 277V 347 · 347V*2/4	Same as Fixture	Same as Fixture	*1 120V only *2 remote mount *3 second driver required *4 not available with ELDO, Lutron or DMX

Project : _____
 Quantity : _____
 Type : _____
 Notes : _____

LETO 11 WM A

WALL MOUNT ASYMMETRIC LED DOWNLIGHT



Reflector

Senso metal spun faceted reflectors are specifically designed to retain as much light as possible. This results in a more power efficient fixture with a higher delivered lumen.



Installation

- Mounting plate included
- Easy, single motion installation method

Construction / Finish

- High quality, scratch resistant powder coated finish in standard, premium or custom colors
- Aluminum extruded Body
- Made in Canada

Dimensions

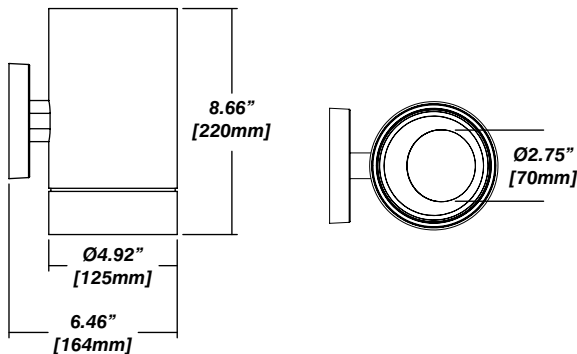

Photometrics

Senso's in-house photometric testing ensures that our lighting design can match your needs precisely. Our Goniophotometer and testing lab produces on-demand photometry files based on any specified fixture, including LM-79 Test reports, IES Files, and CRI/CCT measurements. See Sensolighting.com for more information.

**Full photometric Reports and IES files available for every configuration*

Color Metrics

TM 30-15

Our clients deserve the best information possible about their lighting choices. That's why Senso has invested in the Illuminating Engineering Society (IES) TM 30-15, a new system that measures an LED light source's color rendering properties. Using Senso's state-of-the-art goniophotometer, this method identifies the optimal light source for your project and helps evaluate the trade-offs between efficacy and color rendering. Senso can provide TM 30-15 data for all of our products.

**Full Color Metric Info Available at Sensolighting.com*

LED Module Performance

Output: Up to 113 lumen/Watt

Efficacy: Color consistency within a 3-MacAdam Ellipse

CCT: 2500K - 6500K

Color Rendering: 93+ CRI

Min. R Values: R⁹ - 60 R^f - 90 R^a - 100

Driver and Power Consumption

Dimming: 1% dimming standard with 0.1% option
Casambi wireless control available

Ripple: Industry leading Low ripple

Efficiency: Power Factor >0.9
Efficiency over 85%
Class 2 output for safety

Installation: Remote mounted

Lumen Option	700lm	1000lm	1500lm
Fixture Wattage	6.1W	9.1W	14W
Delivered Lumen	656lm	1035lm	1539lm

LETO 11 WM A

WALL MOUNT ASYMMETRIC LED DOWNLIGHT

Senso Driver Housings

Single Remote Driver Housing

- Fits Standard, LCS or DIM drivers
- Galvanized steel enclosure
- For remote driver applications

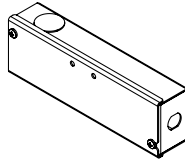

Double Remote Driver Housing

- Fits all drivers
- Galvanized steel enclosure
- For remote driver applications

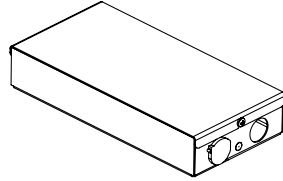

Dimensions

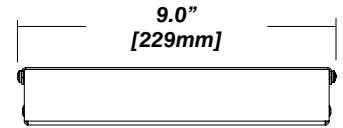
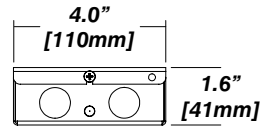
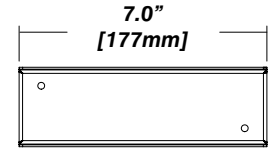
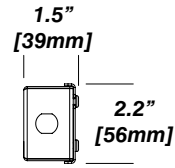

LETO 11

FAMILY

