

Features

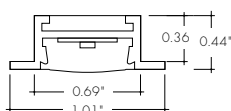

- 24VDC Class 2 and IP68 wet rated for wet locations, fixtures made to order up to 144". Fixtures can be linked up to 30' depending on output
- Suitable for millwork, recessed, architectural reveals, wet, outdoor, and accent lighting applications
- Dot free even illumination with frosted lens
- Proprietary strong bond solder method handles up to 50 lbs of pull force on wire leads and connectors
- 3 year warranty.
- WD68 Warm Dim follows the incandescent dimming curve and is compatible with MLV, ELV, and Incandescent dimmers.
- DW68 Dynamic White allows individual control of CCT and output
- RGB options offer balanced output across the color gamut and a true white with RGBW
- Smart Pixel offerings allow for infinite color combinations with cascading and chasing effects.



Finish Options (see page 2 for additional information)

- Silver Anodized
- Black
- Bronze
- White
- Matte Black
- Warm Nickel
- Aged Brass
- Polished Gold
- Chrome

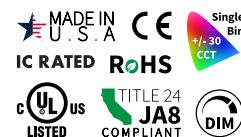

Technical Information

TYPE	Warm Dim	Dynamic White		RGBW	RGB	Pixel	
OUTPUT OPTIONS	WD68SO (22K-32K)	DW68SO (22K-46K)	DW68HO (22K-46K)	RGBW36SO	RGB42SO	RGBWX18SO	RGBX18SO
Lumens Output (all channels full on) (with a Clear Lens)	210 lm/ft	255 lm/ft	306 lm/ft	128 lm/ft	127 lm/ft	155 lm/ft	102 lm/ft
Average Power Consumption (for a 4" section)	5.4 W/ft	4.6 W/ft	5.6 W/ft	4 W/ft	4.5 W/ft	5.7 W/ft	4.5 W/ft
Efficacy	39 lm/W	55 lm/W	55 lm/W	32 lm/W	28 lm/W	27 lm/W	23 lm/W
Max Run Length (in series)	20 ft	32 ft	32 ft	26 ft	28 ft	20 ft	30 ft
Max Ambient Temperature*	45°C [113°F]	50°C [122°F]	45°C [113°F]	50°C [122°F]	45°C [113°F]	40°C [104°F]	50°C [122°F]
Control/Dimming Protocol	MLV, ELV, Inc.	0-10V, DMX		DMX		SPI Protocol UCS 2904	SPI Protocol UCS 2903

*Max Ambient Temperature to maintain L70 of 50k+ hours. Exceeding Max Ambient Temperature may result in decreased life/output. Consult Technical Support for specific inquiries.

Warm Dim (WD68)					Dynamic White (DW68)					RGBW (4000K)				Dominant Wavelength		
CCT		TM-30			CCT		TM-30			Tape		TM-30		Color	RGB/RGBW	
CRI	R _f	R _f	R _g	R _g	R _g	R _g	R _g	R _g	CRI	R _f	R _g	R _g				
2200K	96	92	96	94	2200K	97	94	98	95	RGBW36	95	93	106	84	Red	620nm
3200K	96	93	106	95	3500K	98	96	102	94	RGBWX18	93	91	99	64	Green	525nm
					4600K	97	94	105	97						Blue	467nm

Ordering Code

MODEL	LENGTH ¹	OUTPUT	CCT	LENS	MOUNTING	FINISH ²	POSITION	POWER FEED
KRSW - Kendo S Recessed Wet	12"-144" 3" increments	WD68SO - Standard	22K32K - 2200K - 3200K	C - Clear lens F - Frosted	HS - Hard Surface Mounting Bracket GS - Gypsum Surface Mounting Bracket NB - No Bracket	SA - Silver Anodized BK - Black BZ - Bronze WH - White MBK - Matte Black WN - Warm Nickel AB - Aged Brass PG - Polished Gold ³ CH - Chrome ³	B - Back	1 - 72" wire leads 1X2 - 72" wire leads at both ends 2 - 72" wire leads at one end and Quick Connect at other 3 - Single Quick Connect 4 - Quick Connect at both ends P1 - Plenum rated 72" wires on one end PIX2 - Plenum rated 72" wires on both ends
	12"-144" 3" increments	DW68SO - Standard DW68HO - High	22K46K - 2200K - 4600K					
	12"-144" 2" increments	RGBW36SO - Standard RGB42SO - Standard	CLR - Color					
	12"-144" 4" increments	RGBWX18SO - Standard RGBX18SO - Standard	PXSPI - Smart Pixel Control					

1 - Custom lengths and increments are available, please consult Inside Sales with specific request.
2 - Warm Dim and Dynamic White options can be used to comply with Title 24 JAB at max brightness depending on lens selection, see multiplier charts to calculate specific efficacy.

3 - Non SA finishes may have extended lead times. Custom RALs are available, please consult Inside Sales with specific request.
4 - Polished Gold finishes have a maximum fixture length of 48", and Chrome finishes have a maximum fixture length of 72".

Product Dimensions

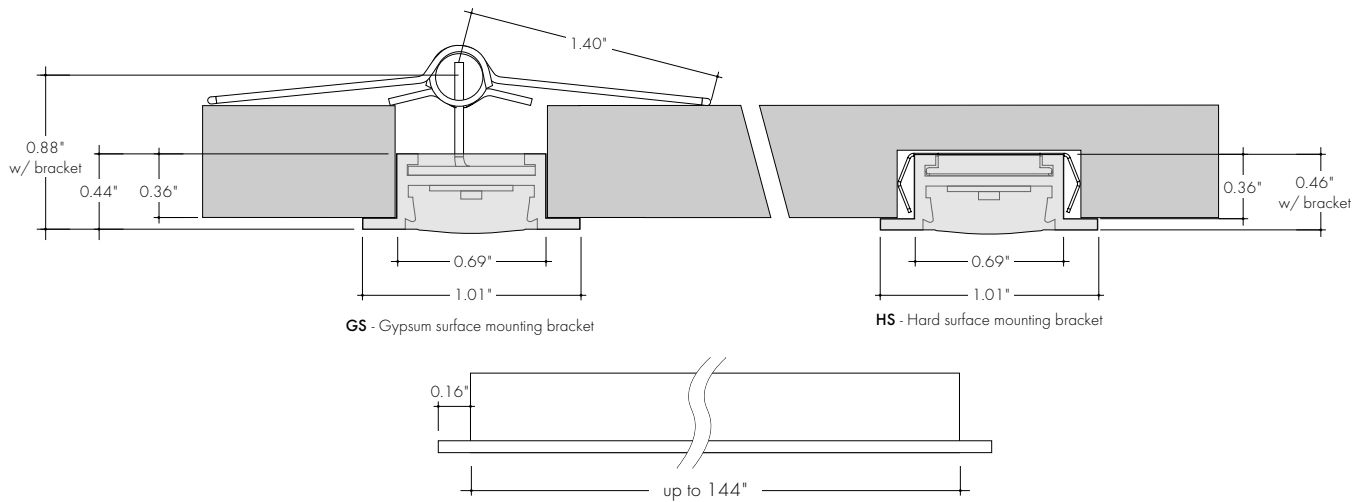

Finish Options

- Finish options are available in a wide variety, allowing for complete customization of style and aesthetic.
- Non Silver Anodized finishes may have extended lead times.
- Polished Gold finishes have a maximum fixture length of 48", and Chrome finishes have a maximum fixture length of 72".
- Custom RALs are available, please consult Inside Sales with specific request.

Silver Anodized

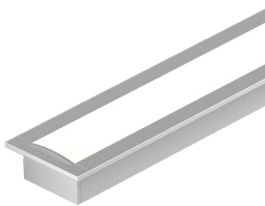

Silver Anodized is a soft silver with a clear finish.

Black



Black is a true deep black with a glossy finish.

Bronze



Bronze is a rich, dark brown with a satin finish.

White



White is a polar bright white and field paintable.

Matte Black



Matte Black is a dark, pitch-black with a soft flat finish.

Warm Nickel



Warm Nickel is a soft, silvery smoke with warm tones and a satin finish.

Aged Brass



Aged Brass is a deep brown shade with slightly golden undertones.

Polished Gold

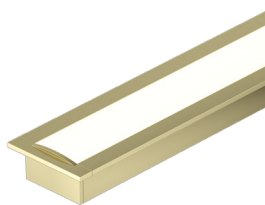

Polished Gold is bright and radiant for a brilliant finish.

Chrome



Chrome is a highly reflective silver polish.

Powerfeeds and Connectors

Linking and Extension Cable Options

For use with Warm Dim (WD68):

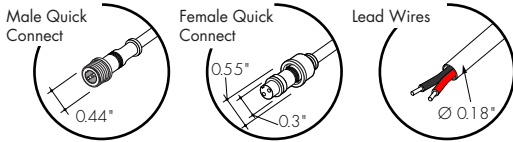

WET-FMA-2-2
Female to Male Adapter, 2 pin

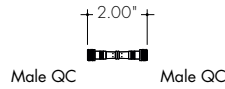

WET-CON-LEAD-M-2-48
Male Wet Connector Cable, 2 pin, 48"

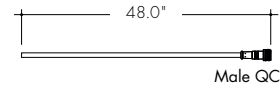

WET-CON-JC-F-M-2-48
Female/Male Wet Jumper Cable, 2 pin, 48"

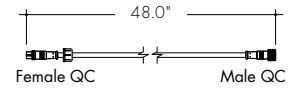

For use with Dynamic White (DW68), RGB Pixel (RGBX18) and RGBW Pixel (RGBWX18):

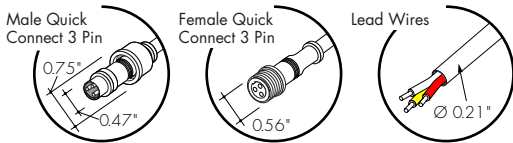

WET-MFA-3-2
Male to Female Adapter, 3 pin

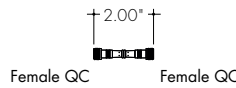

WET-CON-LEAD-F-3-48
Female Wet Connector Cable, 3 pin, 48"

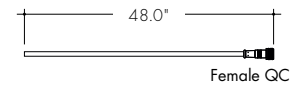

WET-CON-JC-M-F-3-48
Male/Female Wet Jumper Cable, 3 pin, 48"

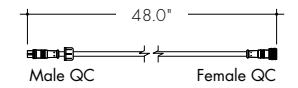

For use with RGB (RGB42):

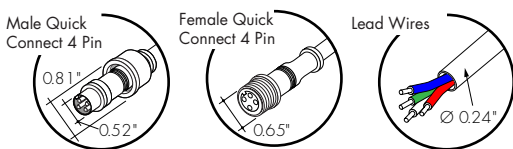

WET-MFA-4-2
Male to Female Adapter, 4 pin

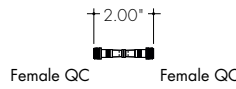

WET-CON-LEAD-F-4-48
Female Wet Connector Cable, 4 pin, 48"

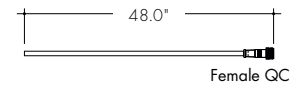

WET-CON-JC-M-F-4-48
Male/Female Wet Jumper Cable, 4 pin, 48"

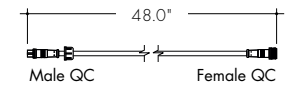

For use with RGBW (RGBW36):

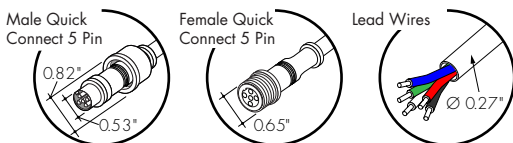

WET-MFA-5-2
Male to Female Adapter, 5 pin

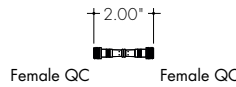

WET-CON-LEAD-F-5-48
Female Wet Connector Cable, 5 pin, 48"

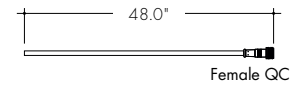

WET-CON-JC-M-F-5-48
Male/Female Wet Jumper Cable, 5 pin, 48"

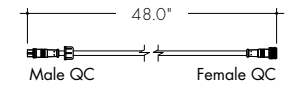

Powerfeeds Position/Type

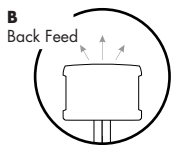

1 / P1
72" wire leads / Plenum rated 72" wire leads



2
72" wire leads at one end and Female Quick Connect at other

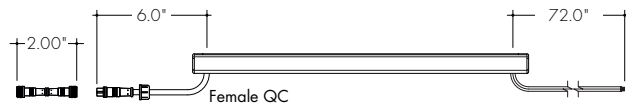

4
Female Quick Connect at both ends



1X2 / P1X2
72" wire leads at both ends / Plenum rated 72" wire leads at both ends



3
Single Female Quick Connect



All wires are 18 AWG unless otherwise specified

Sample Layout

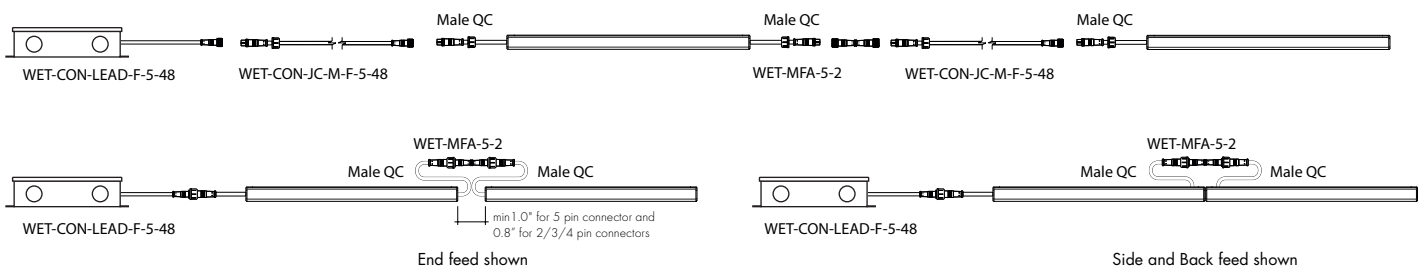

Lens Option / Light Transmission

Output Options	Lens/Accessory	
	Clear Lens	Frosted Lens
WD68SO - 27K	CD	ND
WD68SO - 19K	CD	CD
DW68SO (All On)	CD	ND
DW68SO (1-Channel)	CD	CD
DW68HO (All On)	CD	ND
DW68HO (1-Channel)	CD	CD
RGBW36SO	CD	CD
RGBW36HO	CD	CD
RGB42SO	CD	ND
RGB42HO	CD	ND
RGBWX18SO	CD	CD
RGBX18SO	CD	CD
Transmission Percentage	100%	55%



CD SD ND
CD - Clear Dotting
SD - Slight Dotting
ND - No Dotting

Accessory Options

LVSP-WET

Splice box: wet rated, low voltage, gray

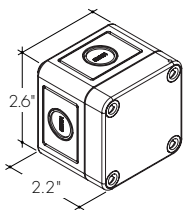

LVSP-WET-CM

Connector for splice box, low voltage for cable management, gray.

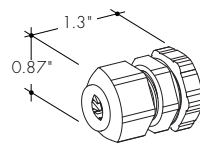

Power Consumption

Tested at Full Power with PDC Series power supplies.

Standard Nominal Lengths offered provide minimal shadowing. For alternate lengths, please contact factory with specific request.

Warm Dim (WD68)

Nominal Length (in)	Back Feed Actual Length	Watts SO	Nominal Length (in)	Back Feed Actual Length	Watts SO	Nominal Length (in)	Back Feed Actual Length	Watts SO	Nominal Length (in)	Back Feed Actual Length	Watts SO
12	10 11/16	4.6	47	-	-	82	-	-	117	116 8/16	47.5
13	-	-	48	47 10/16	21.0	83	82 1/16	34.8	118	-	-
14	13 3/16	5.8	49	-	-	84	-	-	119	119	48.3
15	-	-	50	-	-	85	84 9/16	35.7	120	-	-
16	15 10/16	6.9	51	50 1/16	22.0	86	-	-	121	-	-
17	-	-	52	-	-	87	87	36.7	122	121 7/16	49.1
18	-	-	53	52 9/16	23.0	88	-	-	123	-	-
19	18 2/16	8.0	54	-	-	89	-	-	124	123 15/16	49.9
20	-	-	55	-	-	90	89 7/16	37.6	125	-	-
21	20 9/16	9.1	56	55	24.1	91	-	-	126	-	-
22	-	-	57	-	-	92	91 15/16	38.6	127	126 6/16	50.6
23	-	-	58	57 8/16	25.1	93	-	-	128	-	-
24	23	10.2	59	-	-	94	-	-	129	128 13/16	51.5
25	-	-	60	59 15/16	26.1	95	94 6/16	39.6	130	-	-
26	25 8/16	11.3	61	-	-	96	-	-	131	-	-
27	-	-	62	-	-	97	96 13/16	40.5	132	131 5/16	52.5
28	27 15/16	12.3	63	62 6/16	27.1	98	-	-	133	-	-
29	-	-	64	-	-	99	-	-	134	133 12/16	53.3
30	-	-	65	64 14/16	28.0	100	99 5/16	41.4	135	-	-
31	30 6/16	13.4	66	-	-	101	-	-	136	-	-
32	-	-	67	-	-	102	101 12/16	42.2	137	136 3/16	54.2
33	32 14/16	14.5	68	67 5/16	29.0	103	-	-	138	-	-
34	-	-	69	-	-	104	-	-	139	138 11/16	54.8
35	-	-	70	69 12/16	30.0	105	104 4/16	43.0	140	-	-
36	35 5/16	15.6	71	-	-	106	-	-	141	-	-
37	-	-	72	-	-	107	106 11/16	43.9	142	141 2/16	55.4
38	37 13/16	16.7	73	72 4/16	30.9	108	-	-	143	-	-
39	-	-	74	-	-	109	-	-	144	143 9/16	56.2
40	-	-	75	74 11/16	32.0	110	109 2/16	44.8			
41	40 4/16	17.8	76	-	-	111	-	-			
42	-	-	77	-	-	112	111 10/16	45.8			
43	42 11/16	18.9	78	77 2/16	33.1	113	-	-			
44	-	-	79	-	-	114	-	-			
45	-	-	80	79 10/16	33.9	115	114 1/16	46.6			
46	45 3/16	20.0	81	-	-	116	-	-			

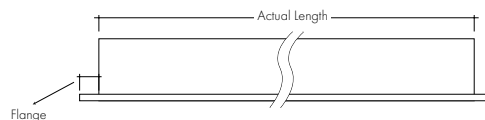

Power Consumption

Tested at Full Power with PDC Series power supplies.

Standard Nominal Lengths offered provide minimal shadowing. For alternate lengths, please contact factory with specific request.

Dynamic White (DW68)

Nominal Length (in)	Back Feed Actual Length	Watts		Nominal Length (in)	Back Feed Actual Length	Watts		Nominal Length (in)	Back Feed Actual Length	Watts		Nominal Length (in)	Back Feed Actual Length	Watts	
		SO	HO			SO	HO			SO	HO			SO	HO
12	10 11/16	4.6	5.9	47	-	-	-	82	-	-	-	117	116 8/16	41.5	50.8
13	-	-	-	48	47 10/16	18.3	23.1	83	82 1/16	29.9	37.3	118	-	-	-
14	13 3/16	4.6	5.9	49	-	-	-	84	-	-	-	119	119	41.9	51.5
15	-	-	-	50	-	-	-	85	84 9/16	30.5	38.5	120	-	-	-
16	15 10/16	5.9	7.4	51	50 1/16	19.0	24.0	86	-	-	-	121	-	-	-
17	-	-	-	52	-	-	-	87	87	31.4	39.5	122	121 7/16	42.7	52.5
18	-	-	-	53	52 9/16	20.0	25.4	88	-	-	-	123	-	-	-
19	18 2/16	6.7	8.4	54	-	-	-	89	-	-	-	124	123 14/16	43.3	53.0
20	-	-	-	55	-	-	-	90	89 7/16	32.7	40.9	125	-	-	-
21	20 9/16	7.9	9.8	56	55	20.7	26.3	91	-	-	-	126	-	-	-
22	-	-	-	57	-	-	-	92	91 15/16	33.6	41.8	127	126 6/16	44.0	53.5
23	-	-	-	58	57 8/16	21.8	27.7	93	-	-	-	128	-	-	-
24	23	8.7	10.8	59	-	-	-	94	-	-	-	129	128 13/16	45.0	54.3
25	-	-	-	60	59 15/16	22.5	28.6	95	94 6/16	34.9	43.3	130	-	-	-
26	25 8/16	9.8	12.3	61	-	-	-	96	-	-	-	131	-	-	-
27	-	-	-	62	-	-	-	97	96 13/16	35.8	44.2	132	131 5/16	45.6	54.8
28	27 15/16	10.6	13.3	63	62 6/16	23.7	29.8	98	-	-	-	133	-	-	-
29	-	-	-	64	-	-	-	99	-	-	-	134	133 12/16	46.5	55.7
30	-	-	-	65	64 14/16	24.6	30.6	100	99 5/16	36.4	44.8	135	-	-	-
31	30 6/16	11.8	14.8	66	-	-	-	101	-	-	-	136	-	-	-
32	-	-	-	67	-	-	-	102	101 12/16	37.4	45.7	137	136 3/16	46.8	56.3
33	32 14/16	12.6	15.8	68	67 5/16	25.4	31.3	103	-	-	-	138	-	-	-
34	-	-	-	69	-	-	-	104	-	-	-	139	138 11/16	47.3	57.4
35	-	-	-	70	69 12/16	26.7	32.4	105	104 4/16	38.0	46.3	140	-	-	-
36	35 5/16	13.4	16.8	71	-	-	-	106	-	-	-	141	-	-	-
37	-	-	-	72	-	-	-	107	106 11/16	39.0	47.2	142	141 2/16	47.6	58.1
38	37 13/16	14.5	18.3	73	72 4/16	27.6	33.1	108	-	-	-	143	-	-	-
39	-	-	-	74	-	-	-	109	-	-	-	144	143 9/16	48.1	59.1
40	-	-	-	75	74 11/16	28.4	34.3	110	109 2/16	39.7	47.8				
41	40 4/16	15.3	19.3	76	-	-	-	111	-	-	-				
42	-	-	-	77	-	-	-	112	111 10/16	40.3	48.9				
43	42 11/16	16.4	20.7	78	77 2/16	28.9	35.2	113	-	-	-				
44	-	-	-	79	-	-	-	114	-	-	-				
45	-	-	-	80	79 10/16	29.5	36.4	115	114 1/16	40.8	49.7				
46	45 3/16	17.2	21.7	81	-	-	-	116	-	-	-				

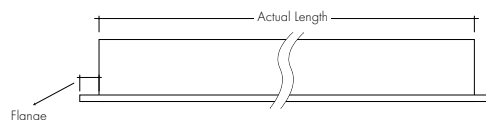

Power Consumption

Tested at Full Power with PDC Series power supplies.

Standard Nominal Lengths offered provide minimal shadowing. For alternate lengths, please contact factory with specific request.

RGB/RGBW (RGB42/RGBW36)

Nominal Length (in)	Back Feed Actual Length	Watts		Nominal Length (in)	Back Feed Actual Length	Watts		Nominal Length (in)	Back Feed Actual Length	Watts		Nominal Length (in)	Back Feed Actual Length	Watts	
		RGBW36	RGB42			RGBW36	RGB42			RGBW36	RGB42			RGBW36	RGB42
		SO	SO			SO	SO			SO	SO			SO	SO
12	10 11/16	4.0	4.4	47	46 2/16	14.4	16.8	82	81 9/16	26.1	29.4	117	--	--	--
13	12 11/16	4.0	4.4	48	--	--	--	83	--	--	--	118	117	37.1	41.3
14	--	--	--	49	48 2/16	15.1	17.5	84	83 9/16	26.8	30.0	119	119	37.8	41.9
15	14 10/16	4.5	5.2	50	--	--	--	85	--	--	--	120	--	--	--
16	--	--	--	51	50 1/16	15.8	18.3	86	85 8/16	27.4	30.7	121	120 15/16	38.6	42.6
17	16 10/16	5.1	5.9	52	--	--	--	87	--	--	--	122	--	--	--
18	--	--	--	53	52 1/16	16.4	18.9	88	87 8/16	28.0	31.4	123	122 15/16	39.2	43.2
19	18 9/16	5.6	6.7	54	--	--	--	89	--	--	--	124	--	--	--
20	--	--	--	55	54	17.0	19.6	90	89 7/16	28.6	32.2	125	124 14/16	39.7	43.8
21	20 9/16	6.2	7.4	56	56	17.6	20.3	91	--	--	--	126	--	--	--
22	--	--	--	57	--	--	--	92	91 7/16	29.2	32.9	127	126 14/16	40.3	44.4
23	22 8/16	6.7	8.2	58	57 15/16	18.2	21.0	93	--	--	--	128	--	--	--
24	--	--	--	59	--	--	--	94	93 6/16	29.9	33.6	129	128 13/16	40.8	45.0
25	24 8/16	7.3	8.9	60	59 15/16	18.9	21.7	95	--	--	--	130	--	--	--
26	--	--	--	61	--	--	--	96	95 6/16	30.2	34.0	131	130 13/16	41.4	45.6
27	26 7/16	8.0	9.6	62	61 14/16	19.5	22.4	97	--	--	--	132	--	--	--
28	--	--	--	63	--	--	--	98	97 5/16	30.8	34.7	133	132 12/16	41.9	46.3
29	28 7/16	8.6	10.4	64	63 14/16	20.2	23.2	99	--	--	--	134	--	--	--
30	--	--	--	65	--	--	--	100	99 5/16	31.3	35.4	135	134 12/16	42.5	46.8
31	30 6/16	9.3	11.1	66	65 13/16	20.8	24.0	101	--	--	--	136	--	--	--
32	--	--	--	67	--	--	--	102	101 4/16	31.9	36.0	137	136 11/16	43.1	47.3
33	32 6/16	9.7	11.5	68	67 13/16	21.5	24.7	103	--	--	--	138	--	--	--
34	--	--	--	69	--	--	--	104	103 4/16	32.4	36.7	139	138 11/16	43.7	47.8
35	34 5/16	10.3	12.2	70	69 12/16	22.1	25.5	105	--	--	--	140	--	--	--
36	--	--	--	71	--	--	--	106	105 3/16	32.9	37.3	141	140 10/16	44.3	48.3
37	36 5/16	11.0	13.0	72	71 12/16	22.8	26.3	107	--	--	--	142	--	--	--
38	--	--	--	73	--	--	--	108	107 3/16	33.5	38.0	143	142 10/16	44.9	48.8
39	38 4/16	11.7	13.7	74	73 11/16	23.5	26.9	109	--	--	--	144	--	--	--
40	--	--	--	75	--	--	--	110	109 2/16	34.0	38.6				
41	40 4/16	12.4	14.5	76	75 11/16	24.1	27.6	111	--	--	--				
42	--	--	--	77	--	--	--	112	111 2/16	34.8	39.3				
43	42 3/16	13.1	15.2	78	77 10/16	24.8	28.2	113	--	--	--				
44	--	--	--	79	--	--	--	114	113 1/16	35.6	39.9				
45	44 3/16	13.8	16.0	80	79 10/16	25.4	28.8	115	--	--	--				
46	--	--	--	81	--	--	--	116	115 1/16	36.3	40.6				

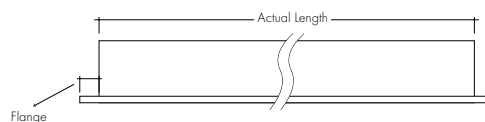

Power Consumption

Tested at Full Power with PDCU Series power supplies.

Standard Nominal Lengths offered provide minimal shadowing. For alternate lengths, please contact factory with specific request.

PIXEL

Nominal Length (in)	Back Feed Actual Length	Watts		Nominal Length (in)	Back Feed Actual Length	Watts		Nominal Length (in)	Back Feed Actual Length	Watts		Nominal Length (in)	Back Feed Actual Length	Watts	
		RGBX18	RGBWX18			RGBX18	RGBWX18			RGBX18	RGBWX18			RGBX18	RGBWX18
		SO	SO			SO	SO			SO	SO			SO	SO
12	8 12/16	4.6	5.7	47	-	-	-	82	-	-	-	117	-	-	-
13	12 11/16	4.6	5.7	48	-	-	-	83	-	-	-	118	-	-	-
14	-	-	-	49	48 2/16	17.4	21.9	84	83 9/16	29.8	37.1	119	119	40.9	51.2
15	-	-	-	50	-	-	-	85	-	-	-	120	-	-	-
16	-	-	-	51	-	-	-	86	-	-	-	121	-	-	-
17	16 10/16	6.1	7.5	52	-	-	-	87	-	-	-	122	-	-	-
18	-	-	-	53	52 1/16	18.9	23.7	88	87 8/16	31.1	38.7	123	122 15/16	42.1	52.8
19	-	-	-	54	-	-	-	89	-	-	-	124	-	-	-
20	-	-	-	55	-	-	-	90	-	-	-	125	-	-	-
21	20 9/16	7.6	9.4	56	56	20.3	25.4	91	-	-	-	126	-	-	-
22	-	-	-	57	-	-	-	92	91 7/16	32.4	40.3	127	126 14/16	43.3	54.3
23	-	-	-	58	-	-	-	93	-	-	-	128	-	-	-
24	-	-	-	59	-	-	-	94	-	-	-	129	-	-	-
25	24 8/16	9.1	11.3	60	59 15/16	21.7	27.1	95	-	-	-	130	-	-	-
26	-	-	-	61	-	-	-	96	95 6/16	33.4	41.6	131	130 13/16	44.5	55.9
27	-	-	-	62	-	-	-	97	-	-	-	132	-	-	-
28	-	-	-	63	-	-	-	98	-	-	-	133	-	-	-
29	28 7/16	10.6	13.2	64	63 14/16	23.0	28.8	99	-	-	-	134	-	-	-
30	-	-	-	65	-	-	-	100	99 5/16	34.6	43.2	135	134 12/16	45.7	57.4
31	-	-	-	66	-	-	-	101	-	-	-	136	-	-	-
32	-	-	-	67	-	-	-	102	-	-	-	137	-	-	-
33	32 6/16	11.7	14.6	68	67 13/16	24.4	30.5	103	-	-	-	138	-	-	-
34	-	-	-	69	-	-	-	104	103 4/16	35.9	44.8	139	138 11/16	46.9	58.9
35	-	-	-	70	-	-	-	105	-	-	-	140	-	-	-
36	-	-	-	71	-	-	-	106	-	-	-	141	-	-	-
37	36 5/16	13.1	16.5	72	71 12/16	25.8	32.3	107	-	-	-	142	-	-	-
38	-	-	-	73	-	-	-	108	107 3/16	37.2	46.4	143	142 10/16	48.0	60.4
39	-	-	-	74	-	-	-	109	-	-	-	144	-	-	-
40	-	-	-	75	-	-	-	110	-	-	-	-	-	-	-
41	40 4/16	14.6	18.3	76	75 11/16	27.1	33.9	111	-	-	-	-	-	-	-
42	-	-	-	77	-	-	-	112	111 2/16	38.4	48.0	-	-	-	-
43	-	-	-	78	-	-	-	113	-	-	-	-	-	-	-
44	-	-	-	79	-	-	-	114	-	-	-	-	-	-	-
45	44 3/16	16.0	20.1	80	79 10/16	28.4	35.5	115	-	-	-	-	-	-	-
46	-	-	-	81	-	-	-	116	115 1/16	39.7	49.6	-	-	-	-

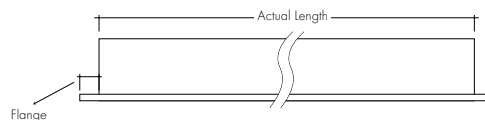

Voltage Drop Calculator

The below chart assumes nominal voltage of 24 Volts and a Voltage Drop Allowance of 3% through the wire

Wattage [W]	Wire Length From Power Supply to Start of Run [ft]						
	12 AWG	14 AWG	16 AWG	18 AWG	20 AWG	22 AWG	24 AWG
5	1088.2	684.4	430.3	270.6	170.2	107.1	67.3
10	544.1	342.2	215.1	135.3	85.1	53.5	33.7
15	362.7	228.1	143.4	90.2	56.7	35.7	22.4
20	272.0	171.1	107.6	67.7	42.6	26.8	16.8
25	217.6	136.9	86.1	54.1	34.0	21.4	13.5
30	181.4	114.1	71.7	45.1	28.4	17.8	11.2
35	155.5	97.8	61.5	38.7	24.3	15.3	9.6
40	136.0	85.5	53.8	33.8	21.3	13.4	8.4
45	120.9	76.0	47.8	30.1	18.9	11.9	7.5
50	108.8	68.4	43.0	27.1	17.0	10.7	6.7
55	98.9	62.2	39.1	24.6	15.5	9.7	6.1
60	90.7	57.0	35.9	22.6	14.2	8.9	5.6
65	83.7	52.6	33.1	20.8	13.1	8.2	5.2
70	77.7	48.9	30.7	19.3	12.2	7.6	4.8
75	72.5	45.6	28.7	18.0	11.3	7.1	4.5
80	68.0	42.8	26.9	16.9	10.6	6.7	4.2
85	64.0	40.3	25.3	15.9	10.0	6.3	4.0
90	60.5	38.0	23.9	15.0	9.5	5.9	3.7
96	56.7	35.6	22.4	14.1	8.9	5.6	3.5

Power Supplies

See fixture and power supply instructions & spec sheet for wiring information. Dimming possible in select models - view Luminii website for list of compatible dimmers.

For use with Warm Dim, WD68

Triac, MLV, & ELV Compatible Dimmers

MODEL	POWER	OUTPUT
PDC - (IP20) Power Supply	96 - 96 Watts	24 - 24 VDC

MODELS	96W
Length	8.25"
Width	4.10"
Depth	1.56"

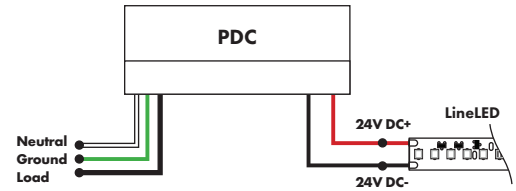

For use with Dynamic White, DW68

0-10V Warm Dimming 0% Power Supply 120VAC - 277VAC
(for warm dimming of Dynamic White option)

MODEL	POWER	OUTPUT
PS010WD - 0-10 Warm dim LED Power Supply	96 - 96 Watt	24 - 24 VDC

Requires a 0-10V controller to work properly

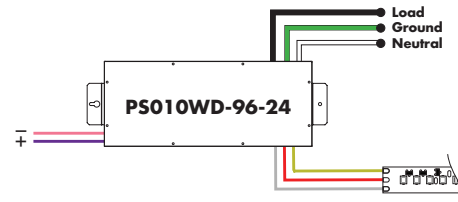

0-10V Tunable White 0% Dimming Power Supply 120VAC - 277VAC
(for tunable white control of Dynamic White option)

MODEL	POWER	OUTPUT
PS010TW - 0-10 Tunable White LED Driver	96 - 96 Watt	24 - 24 VDC

Requires two 0-10V controllers to work properly

MODELS	PS010TW
A Length	14.40"
B Width	2.60"
C Depth	5.20"

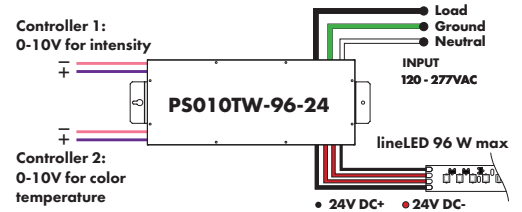

Customizable Dim to Warm or Variable White via 0 - 10V
(for tunable white or warm dimming control of Dynamic option)

MODEL	POWER	OUTPUT	CONTROL
PS010V-0-10 LED Driver	96-96 Watt	24-24 VDC	WW- Standard One Channel - Dim To Warm Curve W2C- Standard Two Channel - Dim 1: Intensity; Dim 2: CCT W21- Standard Two Channel - Dim 1: Warm Channel Intensity; Dim 2: Cool Channel Intensity W1X- Custom One Channel - Dim To Warm Curve W2X- Custom two Channel - Dim 1: Intensity; Dim 2: CCT

Requires a 0-10V controller to work properly

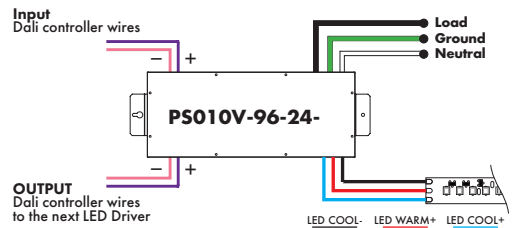

For use with RGB/RGBW/Pixel, RGB42/RGBW36/RGBX18/RGBWX18

Non-Dimming Power Supply 120VAC - 277VAC

MODEL	POWER	OUTPUT	DIMMING	LOCATION
PSV - PSV Series	96 - 96 Watt	24 - 24 VDC	ND - Non Dimming	D - Dry location

Requires a controller and a decoder to work properly

MODELS	96W
A Length	14.40"
B Width	5.20"
Depth	2.60"

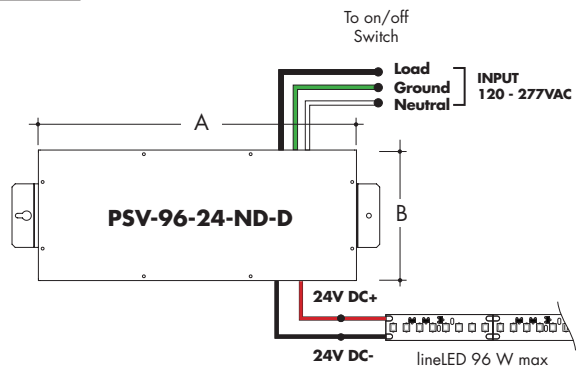

Power Supplies

See fixture and power supply instructions & spec sheet for wiring information. Dimming possible in select models - view Luminii website for list of compatible dimmers.

For use with RGB/RGBW, RGB42/RGBW36 or with Dynamic White, DW68

DMX 0% Dimming Power Supplies 120VAC - 277VAC

MODEL	POWER	OUTPUT
PSDMX-DMX Power Supply dims down to 0%	96 - 96 Watt 3X96 - 3 X 96 Watt	24-24 VDC

Features eldoLED's LINEARdrive configurable dimmable drivers.

DDMX-RGBW DMX Decoder not required when purchasing this power supply.

MODELS	96W	3X96
A Length	14.40"	15.75"
B Width	5.20"	6.62"
Depth	2.60"	4.95"

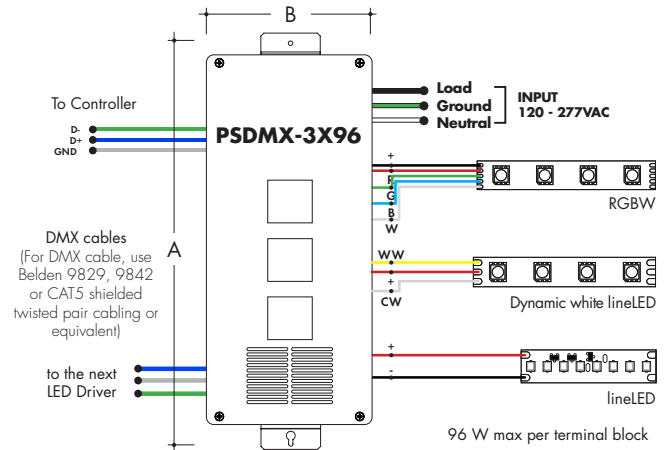
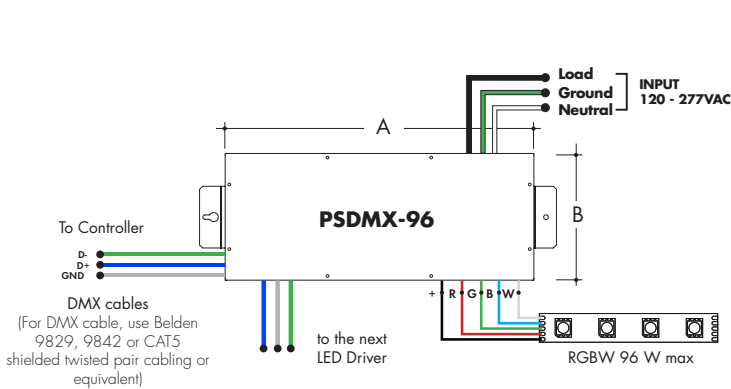

DMX-1Z-RGBW, DMX-3Z-RGBW

RGBW LED 1 or 3 Zone Controller

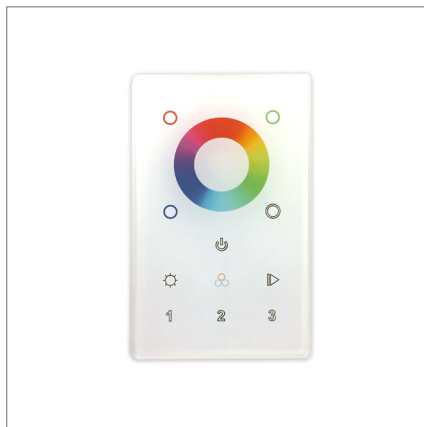

ORDERING CODE

MODEL	ZONES	COLOR
DMX - DMX Controller	3Z - Three Zone 1Z - One Zone	RGBW - Red, Green, Blue, & White

DMX /Wireless RGB-W wall-mount controller controls DMX lighting fixtures, wireless control of RGB-W lighting fixture or use both simultaneously. Fits in any standard US switch box. Includes all the outputs in the back of the controller.

Control brightness levels with a single touch, personalize and memorize 3 different scenes, and even create 3 variations of white.

Features

- 2 in 1 in-Wall Controller: DMX Control or Wireless RGB-W
- 65,000 Color Options, Dimming and Speed Control
- Memory Function
- 50 Foot Wireless Range
- Easily Fits Standard US Switch Boxes
- Touch Sensitive Glass Surface
- Includes 10 Built in Programs, or Create and Play Your Own

Operating Voltage

12 - 24V DC

Color Parameters

- Brightness
- Saturation
- Primary colors
- Fading
- Color changing speed

Touch DMX Controller

Touchscreen digital LED controller

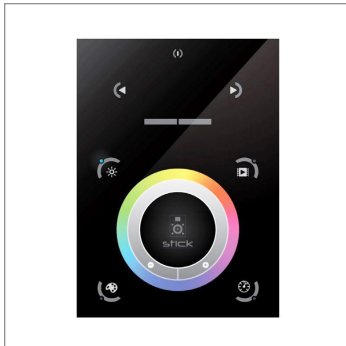

MODEL

TSDMX-E

TSDMX-E - Touchscreen DMX controller

Programmable advanced DMX512 lighting controller featuring a touch-screen interface. Operates as stand alone controller or integrated with most architectural lighting control systems. Can controller endless DMX512 enabled devices.

Mounts to standard single or dual gang wall box with the included power supply inside the junction box. Terminal block design for power and data connections.

Features

- Sleek glass design which sits 0.43" from the wall
- Graphical color display to show selected environment
- Color/dimmer/speed palette
- Color temperature mixing
- Touch sensitive buttons. No mechanical parts
- Touch sensitive wheel allows for accurate color selection
- Multi-zone microSD memory
- Multi-room control with 500 scenes, 10 zones
- 1024 DMX channels. Control 340 RGB fixtures
- USB & Ethernet connectivity for programming and control

Power Supply

7 VDC (included)

Programmability

PC, Mac, Tablet, Smartphone

Output Signal

DMX512 (1024 channels)

Color Parameters

- Brightness
- Saturation
- Speed of color changing sequence
- Fading / dimming / brightness

DMX Decoder

DMX signal to RGBW decoder (required to operate DMX controller)

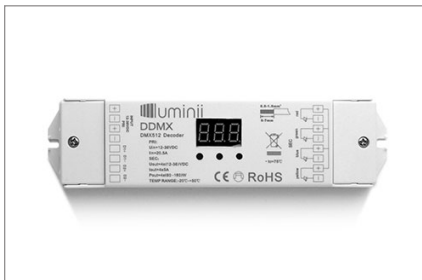

ORDERING CODE

MODEL

DDMX-RGBW

DDMX-RGBW - DMX decoder

Translates controller DMX512 programs for RGB and white LED strips.

Unique DMX address for the decoder can be set easily and displayed by the numeric display on the case. Changing and resetting the DMX address requires manual input.

Use power repeater to expand output.

Operating Voltage

12-36 VDC

Power Capacity

up to 96W at 24V

Operating Temperature Range

from -4°F to +122°F in case

Smart Pixel Decoder

SPI signal to DMX signal decoder



Model

SR-DMX-SPI

SR-DMX-SPI - Smart Pixel Decoder

The SR-DMX-SPI is a smart LED pixel decoder that controls RGB/RGBW pixel LED strips with SPI signal. Designed with an OLED backlit panel, the pixel controller allows for easy configuration of most settings.

Four push buttons are available for control of the LED functions.

*For pixel only.

Features

- 2 in 1 in-Wall Controller: DMX Control or Wireless RGB-W
- SPI signal output for RGB/RGBW pixel light control
- DMX512 controllable and RF/WIFI remote controllable
- Capable of addressing up to 1020 RGB pixels & 765 RGB pixels
- OLED panel allows for easy configuration

Operating Voltage

12 - 36V DC

Power capacity

up to 96W at 24V

Operating temperature range

from -4°F to +122°F in case